

MEASTRO



**Klemmsan**<sup>®</sup>

# TABLE OF CONTENTS

<b>SECTION 1</b>	<b>GENERAL SPECIFICATION.....</b>	<b>27</b>
1.1	General Features.....	28
1.2	Technical Specifications .....	29
1.3	Proper Use and Safety Conditions .....	29
1.4	General View, Connections & Definitions .....	30
<b>SECTION 2</b>	<b>CONTROL.....</b>	<b>31</b>
2.1	Manual Test Mode .....	32
<b>SECTION 3</b>	<b>MENUS AND SETTINGS.....</b>	<b>33</b>
3.1	Settings Menus.....	34
3.1.1	Time and Date Settings.....	34
3.1.2	Location (Coordinate and Region) Settings.....	34
3.1.3	Daylight Saving Time Settings.....	35
3.1.4	Holiday Settings.....	37
3.1.5	Prayer Settings.....	37
3.1.6	Device Settings.....	38
3.2	Add or Modify Programs.....	39
3.2.1	Deleting Programs.....	39
3.3	Monitoring.....	40
3.4	Login.....	41
<b>SECTION 4</b>	<b>IR CONTROLLER AND USER INTERFACE PROGRAM.....</b>	<b>42</b>
4.1	Usage Mods.....	43
4.1.1	Transferring data to MEASTRO-R from the relay.....	44
4.2	User Interface Software.....	44
4.2.1	Setup.....	44
4.2.2	Meastro User Interface Software Opening Page.....	47
<b>FIGURES</b>		
1.1	Display Descriptions .....	30
1.2	General view.....	30
1.3	Connections and wiring .....	30
1.4	Dimensions .....	30
3.1	Time zones .....	36
4.1	General view and definitions for IR Controller .....	43
<b>TABLES</b>		
1.1	Selection Table .....	28
1.2	Technical Specifications. ....	29

The graphic features a complex, interconnected pattern of circles and lines in dark blue and orange. A large orange circle on the left contains the word 'MEASTRO'. A dark blue circle on the right contains the text 'SECTION 1 GENERAL INFORMATIONS'.

**MEASTRO**





**SECTION 1  
GENERAL  
INFORMATIONS**

## SECTION 1 GENERAL FEATURES

### 1.1 General Features

Meastro is an astronomical time relay which calculates sunrise and sunset times for the given coordinates or city selections and turns the relay contacts on and off to control connected systems without any need of photocells or external sensors. Meastro can be used as digital time relay as well. 100 different programmes can be saved to device memory, relay operations are made according to these programmes. A 100 year calendar, sunrise and sunset times are recorded to device memory. The internal battery of the device has 7 years of lifetime. If any power outages occur, the device continues to operate the programme but cannot operate relays or transfer data via remote control. The internal battery prevents data loss due to power interruptions.

Table 1-1 Selection Table

<p>MEASTRO - R</p>  <p>Order Number: 270 720</p>			
<b>Device Model</b>	<b>Meastro 121</b>	<b>Meastro 221</b>	<b>Meastro 321</b>
<b>Order Number</b>	270 702	270 703	270 704
<b>Mounting</b>	Rail mount	Rail mount	Rail mount
<b>Digital Program</b>	✓	✓	✓
<b>Astronomical Program</b>	-	✓	✓
<b>Pray Program</b>	-	-	✓
<b>Number of Relay</b>	2	2	2
<b>IR</b>	✓	✓	✓



The device's default language is English. To set the language in Turkish, press and hold the  button for 4sec, while on the main screen.

## 1.2 Technical Specifications

Operating voltage	180-265VAC
Supply terminals	A1-A2
Number of contacts	2X (AgSnO2)
Rated current	16A/250VAC
Power Consumption	AC Maks. 11 VA
Accuracy	1 sec/day
Renewal period	0,5sec
Display type	LCD
Display size	1.5"
Number of program	100
Duration of the battery reserve	7 years
Protection class	IP20
Operating temperature	-20 °C..+70 °C
Storage temperature	-30 °C..+80 °C
Relative humidity	Max. %95
Mounting	Rail
Weight	126,4 gr
DTS set	Automatic
IR distance	550 mm

Tablo 1-2 Technical Specifications

## 1.3 Proper Use and Safety Conditions

- Installation and connections should be established in accordance with the instructions set out in the manual by authorized persons. Unless the connection is built properly, device should not be operated.
- Before wiring the device up, make sure that energy is cut off
- Use a dry cloth to remove the dust from the device/clean the device. Avoid using alcohol, thinner or a corrosive material.
- Device should be engaged only after all the connections are made.
- Do not open the inside of the device. There are no parts which the users can intervene inside.
- Device should be kept away from humid, wet, vibrant and dusty environments.



The manufacturing company may not be kept responsible for unfavorable incidents that arise out of the failure to follow the above cautions.

1.4 General View, Connections & Definitions(mm)

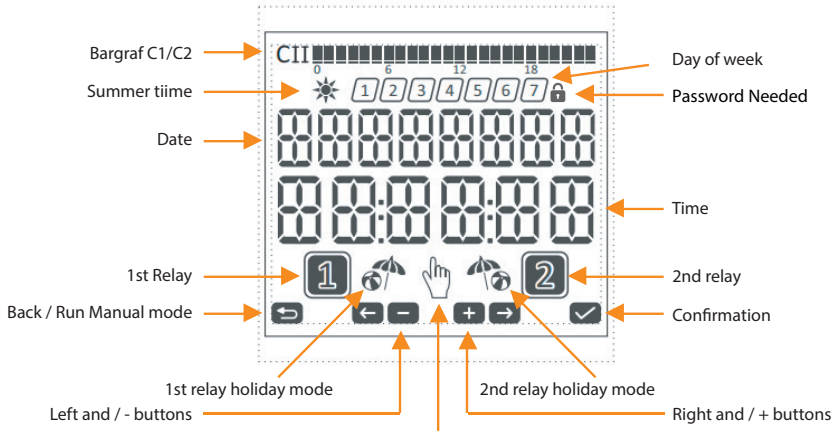

Figure 1-1 Display Descriptions



Figure 1-2 General view

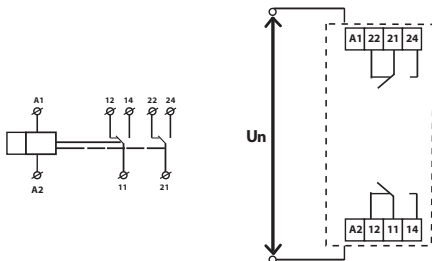

Figure 1-3 Connections and wiring

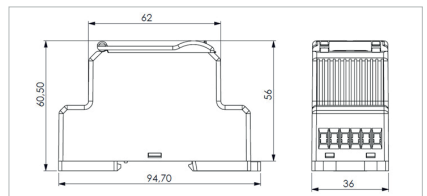

Figure 1-4 Dimensions

The graphic features a complex, interconnected pattern of circles and lines in dark blue and orange. A large orange circle on the left contains the word 'MEASTRO' in grey. A dark blue circle on the right contains the text 'SECTION 2 CONTROL' in orange. The background is white.

**MEASTRO**

**SECTION 2  
CONTROL**

## SECTION 2 CONTROL



Without login, programs and settings menus are not available for access manually! Default password is 0001.

### 2.1 Manual Test Mode

Manual test mode using for relay testing. When you press the button for 4 seconds, flashing symbol becomes permanent light and, icons will appear on the screen. That means C1 and C2 relays are passive condition and directional keys, respectively, C1 and C2 relays can be activated. Pressing the same button again, the relay that you want, became inactive. The active relays are indicated by symbols on the screen and To exit manual mode, press the button for 4 seconds again.

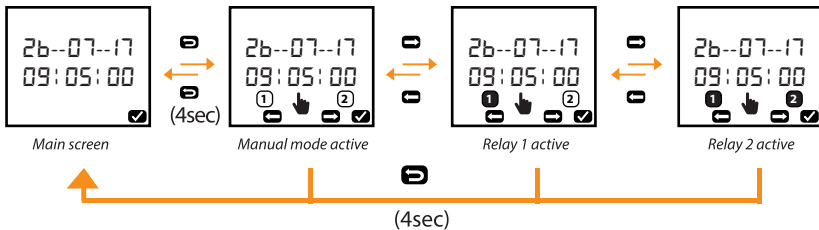



The graphic features a complex, organic shape composed of interconnected circles and lines in dark blue and orange. A large orange circle on the left contains the word 'MEASTRO' in grey. A dark blue circle on the right contains the text 'SECTION 3 MENUS AND SETTINGS' in orange. The overall design is modern and abstract, resembling a network or molecular structure.

**MEASTRO**

**SECTION 3  
MENUS AND  
SETTINGS**

## SECTION3 MENUS AND SETTINGS

### 3.1 Setting Menus

Time and date, location, summer time, holiday mode for each relay, prayer settings and device settings can be made under the settings menu. If the  button is pressed on the home screen reveals the settings menu. You can browse settings menu by using  ,  keys. To make the necessary settings, press  to enter the the desired menu.

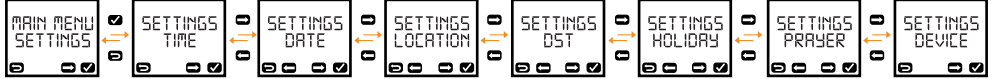

#### 3.1.1 Time & Date settings

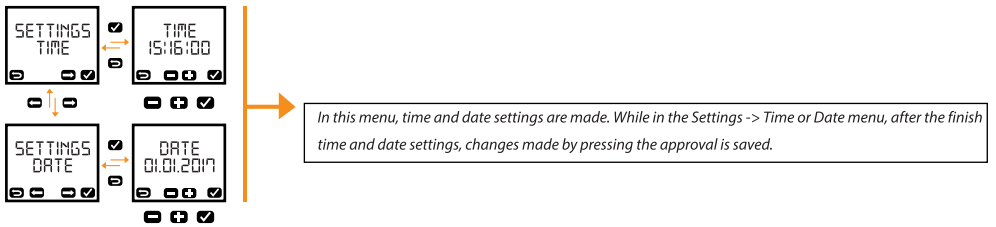

#### 3.1.2 Location (Coordinate and Region) Settings

Coordinates of 81 cities and 161 towns are predefined in device memory. If one of the predefined settings is selected, then sunrise and sunset times are adjusted automatically. If your town is listed in device settings, then you can save your location manually by entering latitude and longitude data.

One of coordinate or region settings should be selected in order to determine sunrise and sunset times for the selections.

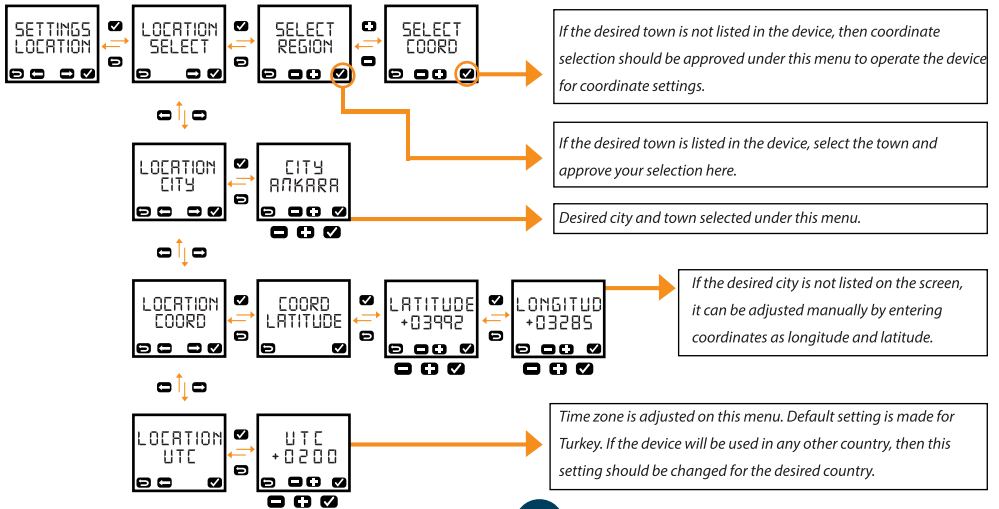

### 3.1.3 Daylight Saving Time Settings

In this menu, daylight saving time settings are made . There are 4 different parameters, Europe, USA, Custom and OFF.

**Europe:** For summer time, clocks go forward 1 hour at 3am on the last Sunday in March, and for winter time, back 1 hour at 3am on the last Sunday in October.

**USA:** Summer time starts on the second Sunday in March. The clocks are moved forward from 2:00 a.m. to 3:00 a.m, and ends on the first Sunday in November, and in fall they are moved back from 2:00 a.m. to 1:00 a.m.

**Custom:** Daylight saving time start and end dates will be set to specific in this menu.

**OFF:** This option turns off the daylight saving time.

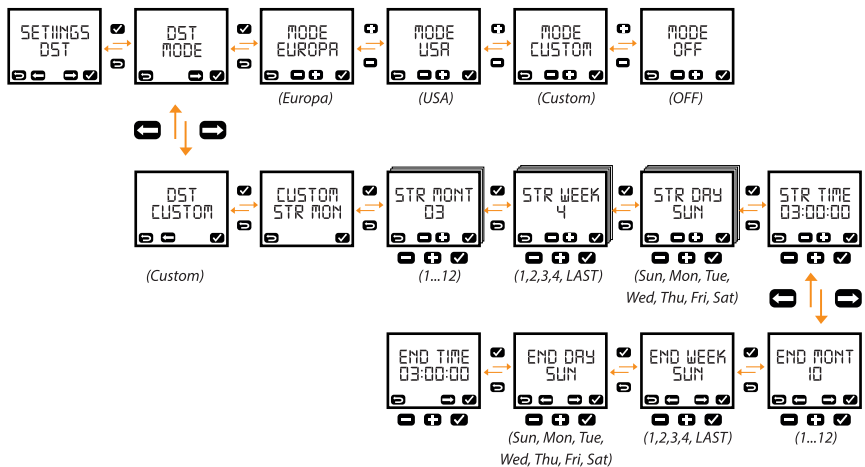

**STR MONT:** Beginning month of the daylight saving time should be adjusted in this menu.

**STR WEEK:** Beginning week of the daylight saving time should be adjusted in this menu.

**STR DAY:** Beginning day of the daylight saving time should be adjusted in this menu.

**STR TIME:** Beginning time of the daylight saving time should be adjusted in this menu.

**END MONT:** Ending month of the daylight saving time should be adjusted in this menu.

**END WEEK:** Ending week of the daylight saving time should be adjusted in this menu.

**END DAY:** Ending day of the daylight saving time should be adjusted in this menu.

**END TIME:** Ending time of the daylight saving time should be adjusted in this menu.

**Time zone overview:**

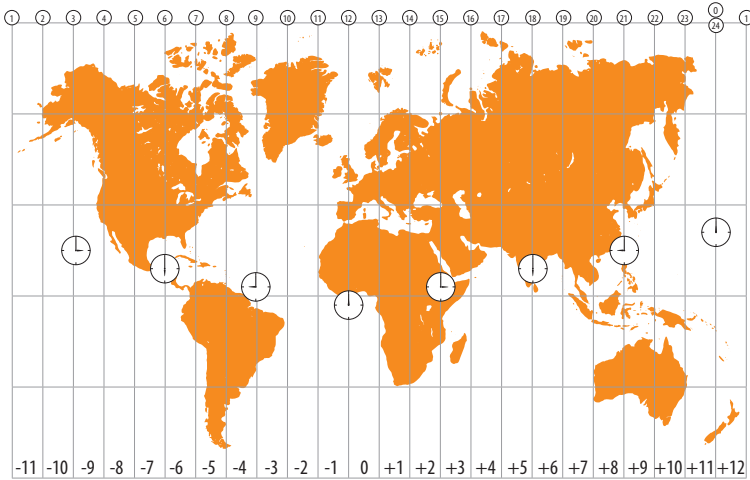

Figure 3-1 Time zones

**Some countries and cities according to UTC time:**

<p>⌚ 21:00</p> <p>BRASILIA RIO DE JANEIRO SAO PAULO</p>	<p>⌚ 22:00</p> <p>Grönland</p>	<p>⌚ 23:00</p> <p>ICELAND DAKAR</p>	<p>⌚ 00:00</p> <p>DUBLIN LONDRA</p>	<p>⌚ 01:00</p> <p>OSLO ROME STOCKHOLM WARSAW FRANKFURT PARIS LISBON VIENNA</p>	<p>⌚ 02:00</p> <p>ANKARA ISTANBUL IZMIR CAIRO ATHENS BEIRUT</p>	<p>⌚ 03:00</p> <p>MOSCOW TEHERAN BAGHDAD NAIROBI RIYADH MADAGASCAR</p>
<p>⌚ 18:00</p> <p>CHICAGO DALLAS MEKSIKO GUATEMALA</p>	<p>⌚ 19:00</p> <p>MONTREAL NEW YORK WASHINGTON CUBA PANAMA</p>	<p>⌚ 20:00</p> <p>NEW FOUNDLAND CARACAS BUENOS AIRES</p>		<p>⌚ 04:00</p> <p>BAHRAIN KARACHI</p>	<p>⌚ 05:00</p> <p>DELHI SRI LANKA BOMBAY</p>	<p>⌚ 06:00</p> <p>BANGLADESH</p>
<p>⌚ 15:00</p> <p>AKLAVIK</p>	<p>⌚ 16:00</p> <p>VANCOUVER SEATTLE SAN FRANCISCO LOS ANGELES</p>	<p>⌚ 17:00</p> <p>SALT LAKE CITY</p>		<p>⌚ 07:00</p> <p>BANGKOK</p>	<p>⌚ 08:00</p> <p>PEKIN HONG KONG PHILIPPINES SINGAPORE JAKARTA</p>	<p>⌚ 09:00</p> <p>TAIPEI TOKYO SEOUL</p>
<p>⌚ 12:00</p> <p>NEW ZEALAND FUJI ISLANDS</p>	<p>⌚ 13:00</p> <p>ALASKA</p>	<p>⌚ 14:00</p> <p>ALASKA HAWAII</p>		<p>⌚ 10:00</p> <p>SYDNEY MELBOURNE NEW GUINEA</p>	<p>⌚ 11:00</p> <p>KAMCHATKA</p>	<p>⌚ 12:00</p> <p>NEW ZEALAND FUJI ISLANDS</p>

### 3.1.4 Holiday Settings

Holiday settings are made under this menu. Holiday programming can be made for both two relays. First, the relay to assign holiday mode is selected, then the action is selected (on or off). If the start position of the relay is selected as on, the relay will be active during the holiday period. If the start position of the relay is selected as off, then the relay will be passive during the holiday. The process is completed by setting start and finish dates for the holiday.

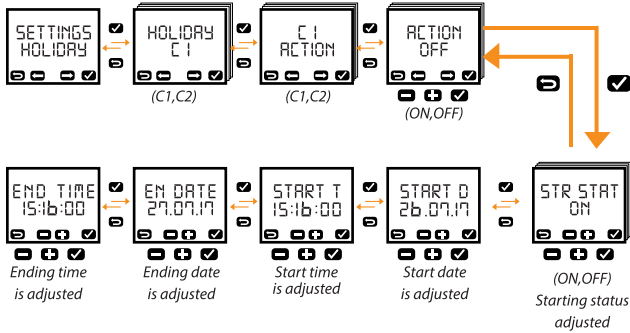

**!** After completing the holiday setup,  icon will appear on the screen for each relay when the date is the adjusted holiday date.

### 3.1.5 Prayer Settings

Device can be configured as prayer timer by using 7 different methods plus manual setting for more customization.

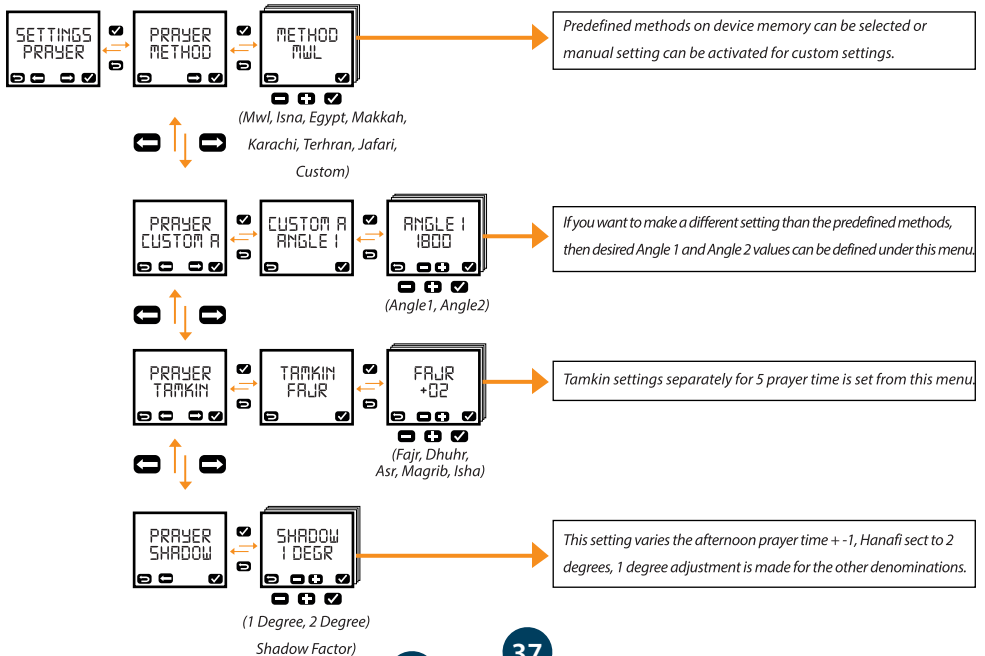

### 3.1.6 Device Settings

The device settings adjusted by changing the parameters under this menu.

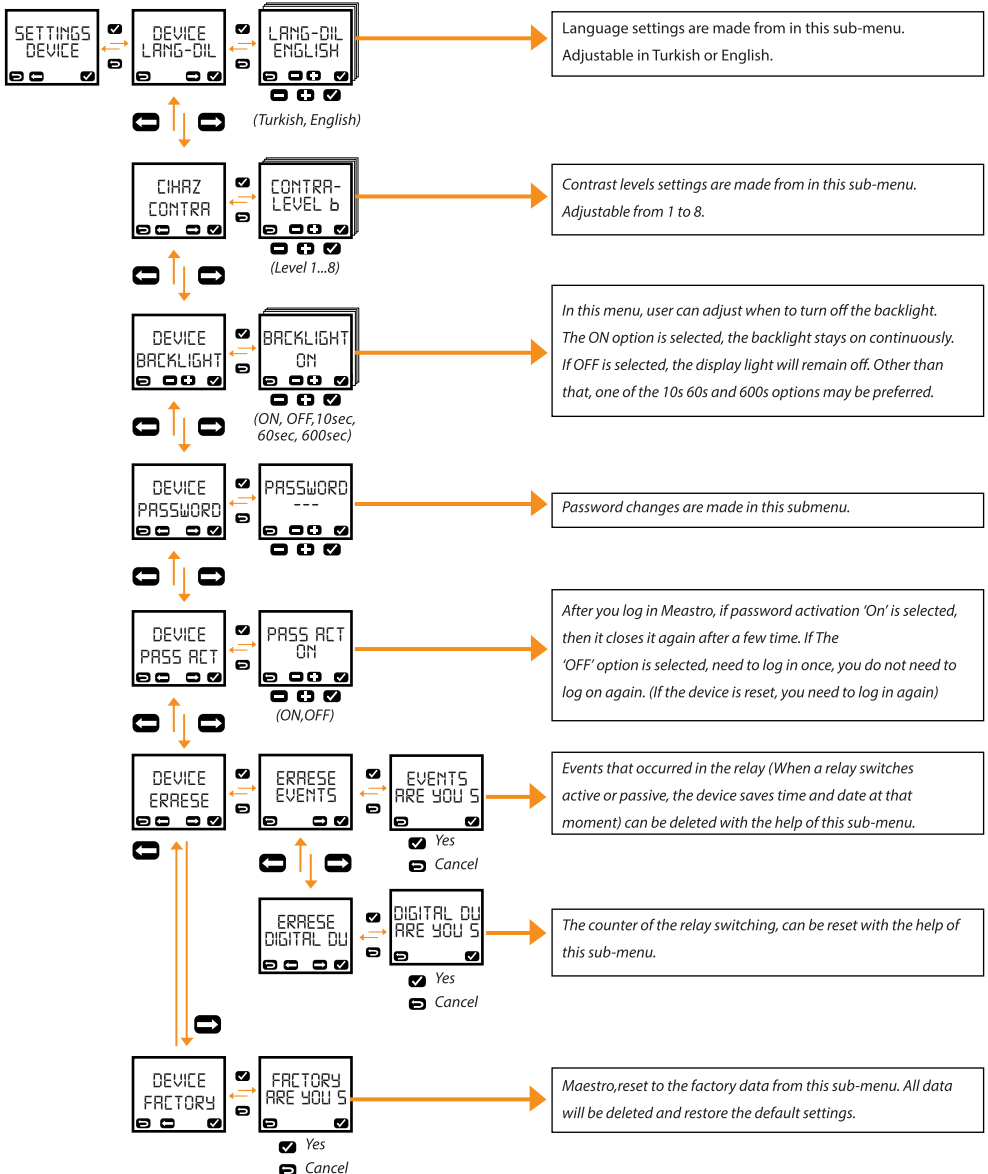

### 3.2 Add or Modify Programs

Adding - modification operations in Meastro are performed from this menu. The program is scheduled weekly and weekly repeats.

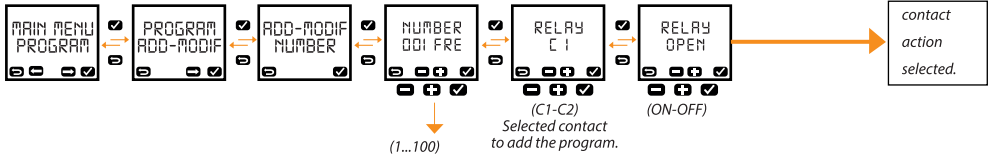

Adding or modify the desired program, is selected sequentially from the sub-menu.

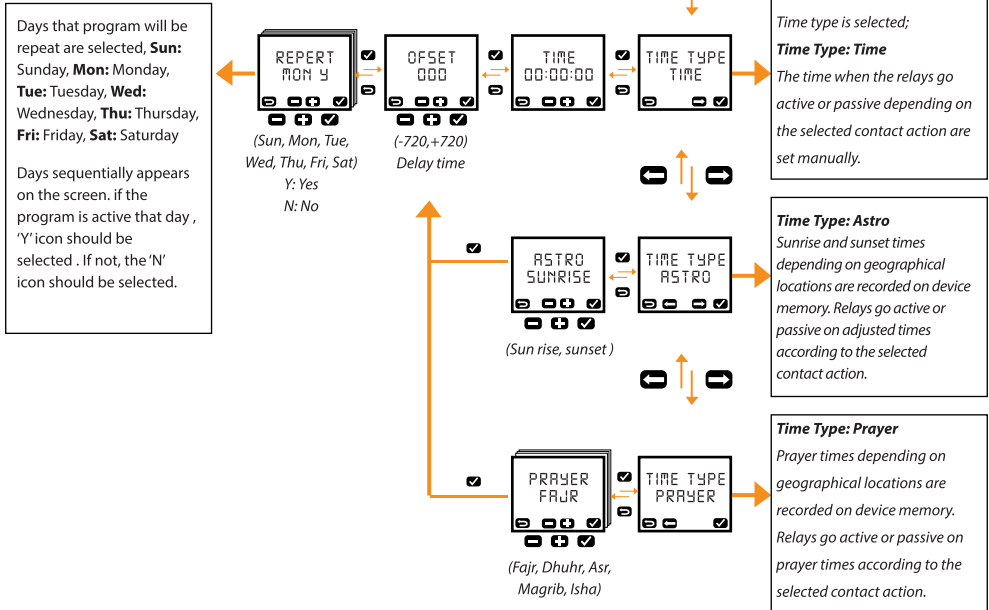

#### 3.2.1 Deleting Programs

Deletion of created entire programs or delete one by one, should be made from this menu. If you want to delete the program, the user confirmation needed. This process is completed with the approval of the User.

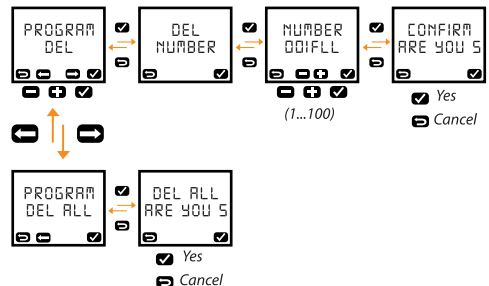

### 3.3 Monitoring

Logs, programs, operating time and switching counters of the relay can be monitored. Also sunrise-sunset, prayer time, holiday and location settings, memory status and the software version of the device can be monitored from this menu.

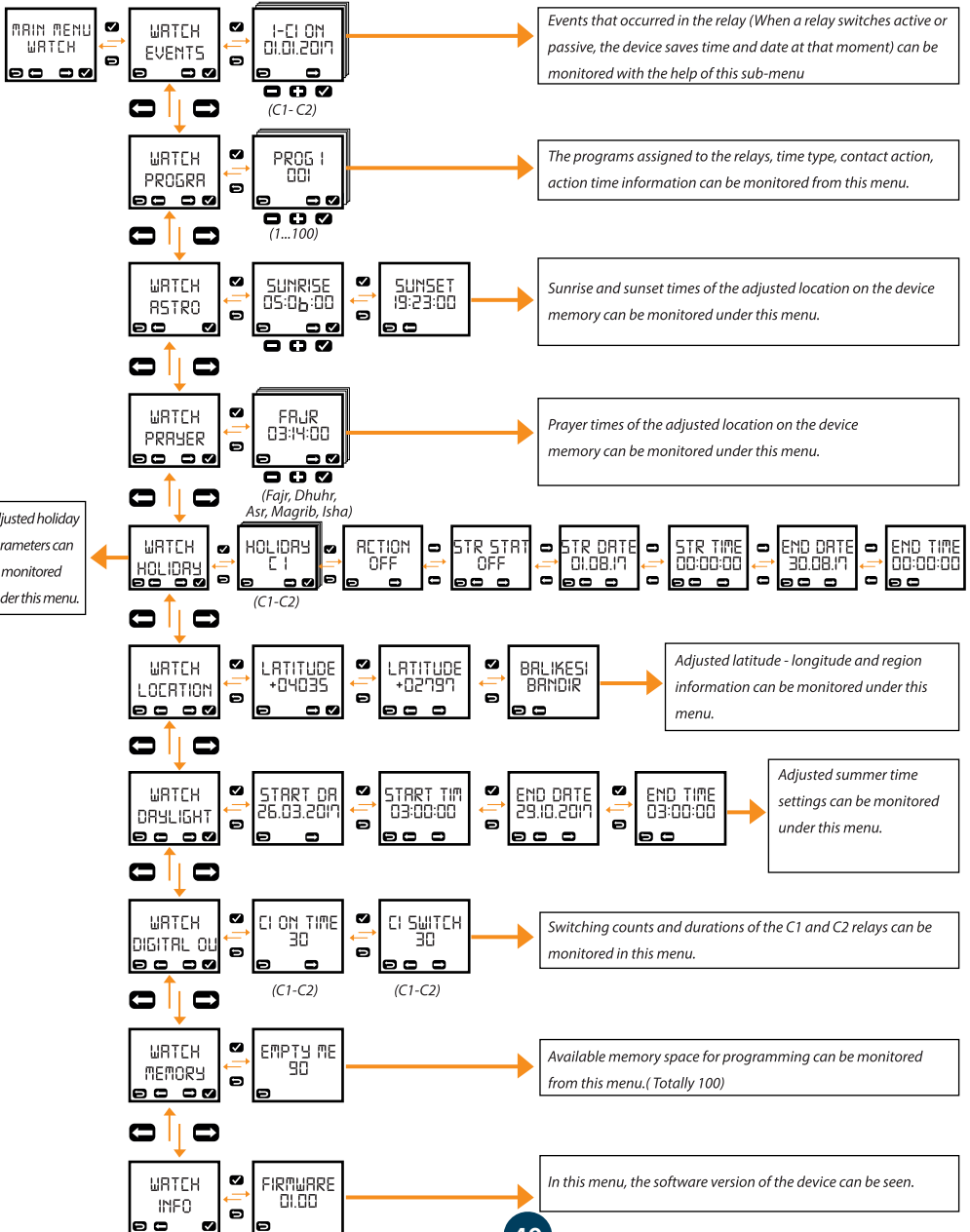



### 3.4 Login

The user login should be done from this menu, or can control the login status.

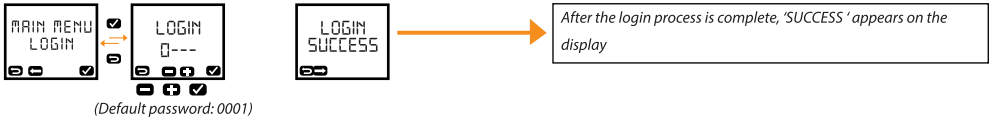

The graphic features a stylized, interconnected network of nodes and lines in dark blue and orange. A large orange circle on the left contains the word 'MEASTRO' in grey. A dark blue circle on the right contains the section title. The background is white.

**MEASTRO**

**SECTION 4  
IR CONTROLLER  
AND USER  
INTERFACE  
PROGRAM**

## SECTION 4 IR CONTROLLER AND USER INTERFACE PROGRAM

MEASTRO-R is a multifunction controller designed for MEASTRO astronomical time relay. The program created by the user interface by installing the infrared data transmission control program, time, location and prayers data separately transferred to the device. Also it can separately transfer program,time,location and prayer datas to controller from relay.

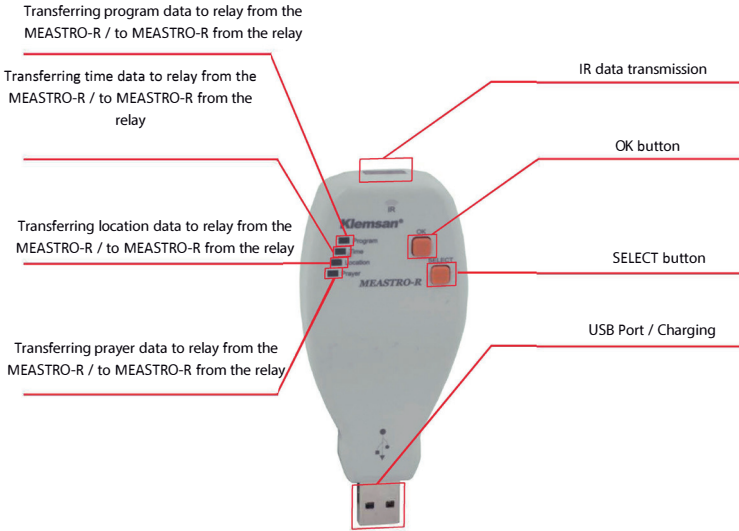

Figure 4-1 General view&Definitions for IR Controller

### 4.1 Usage Mods: USB port:

MEASTRO-R is sent with the USB extension cable.usb is used to charge IR controller or transfer the program that prepared with user interface to the controller.

### Transferring data to relay from the MEASTRO-R:

To turn on the controller to use, It should have been made sure that the controller fully charged. Then, simply press the 'OK' and the 'SELECT' keys briefly at the same time. When remote controller activated, program led lights at first.

For example, in order to transfer the data to the it should be ensured that infrared eyes of the controller and the device is supposed to be on the same axis while the program light is fixed. When pressed the 'OK' button, first `COMM-STR` is shown and then if transmission is successful, `COMM-OK` , if not `COMM-ERR` Is shown. When process failed, it should be ensured that the infrared eyes of the controller and the device is supposed to be on the same axis. Distance should be maximum 50cm.

The other datas(time,location,prayer) can be transferred using the 'SELECT' button. But first you should be ensured that the led fixed. After that, data transmission that you want is performed with 'OK' button.

#### 4.1.1 Transferring data to MEASTRO-R from the relay:

While the program light is fixed, when the selection button is pressed 4 times, 1 cycle is completed and the program light starts blinking. That mode is transferring data from relay to the MEASTRO-R.

Using the Select button, while the led of the data that you want to transfer is flashing, when pressed the OK button, first COMM-STR is shown and then if transmission is successful, COMM-OK; if not COMM-ERR is shown. When process failed, it should be ensured that the infrared eyes of the controller and the device is supposed to be on the same axis. Distance should be maximum 50cm.



If COMM-STR does not appear at all on the screen, the 4 leds blink 3 times simultaneously on the device. Please check controller position and distance. The maximum effective distance between device with IR controller is 50cm..



While IR controller's leds are fixed, when pressing the 'OK' button, refers to the data transfer from controller to the device. While IR controller's lights blinking, when pressing the 'OK' button, refers to the data transfer from device to the controller.

Screenshots:



*Data transfer started*



*Data transfer is successful*



*Data transfer is failed*

\* There is no off button of the MEASTRO-R. If not used turns itself off in 10 seconds.



When the relay's power is cut off, it can not be any transactions between the device and the controller. In addition, if the relay is active, it becomes passive. However, the icons continue to appear on the screen according to the program flow.

## 4.2 User Interface Software

### 4.2.1 Setup

Double-click the Meastro user interface setup file to start the installation.

When you run the setup file, the below screen appears. Please click the "Next" button.

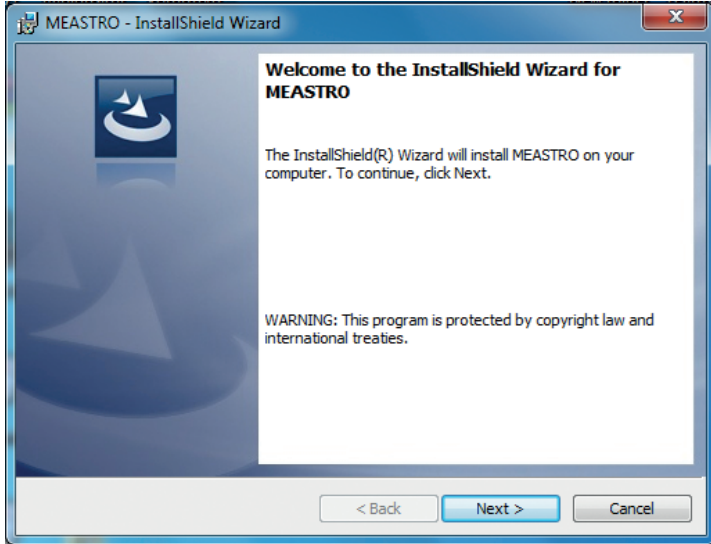

- You will select the installation directory and users on the next screen. Click the “Next” button when you complete your settings..

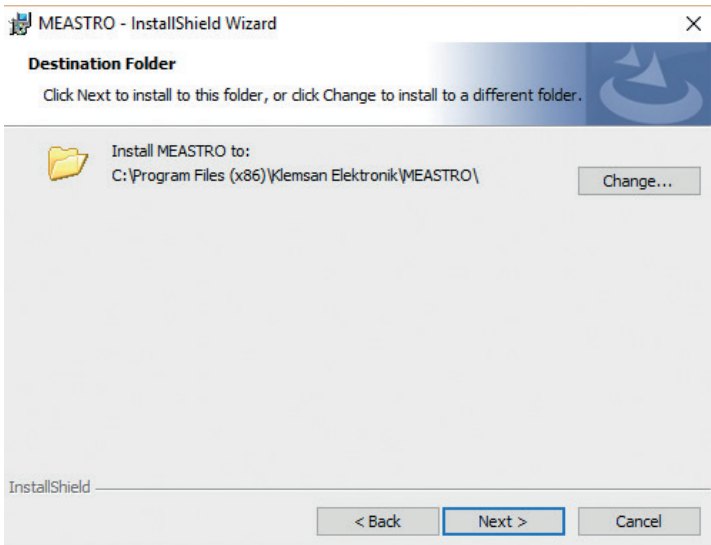

- A review screen appears to check your selections for the installation. If all settings are correct, please click the “Install” button to start the installation..

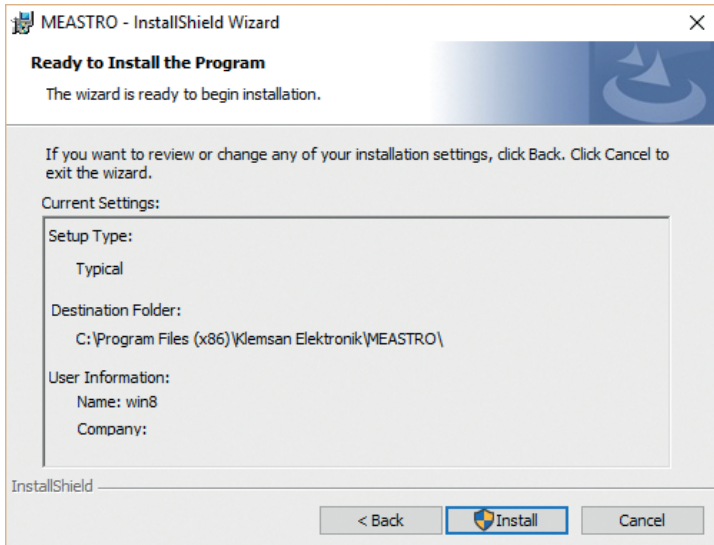

- Your operating system will ask your permission for the installation of the software. Please click “Yes” to install the software..

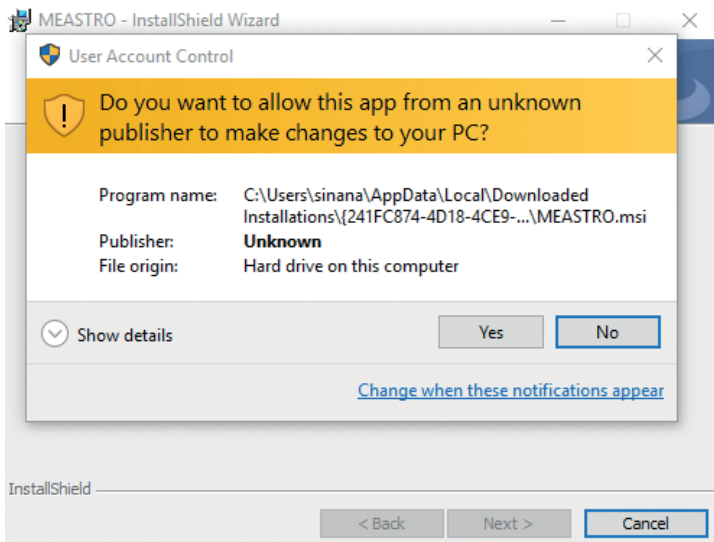

- Please click the “Finish” button to complete the setup and close the setup screen. You can run the software by double clicking the Meastro shortcut on your desktop.

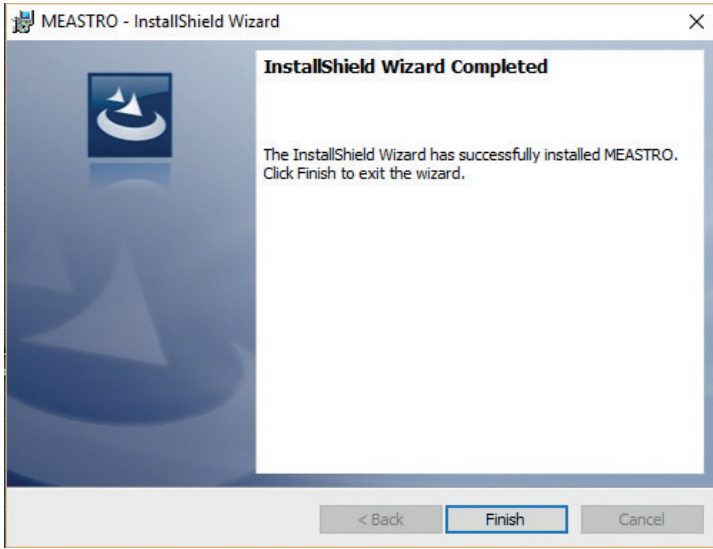

#### 4.2.2 Meastro User Interface Software Opening Page

Double clicking the Meastro shortcut on your desktop will reveal the screen below.

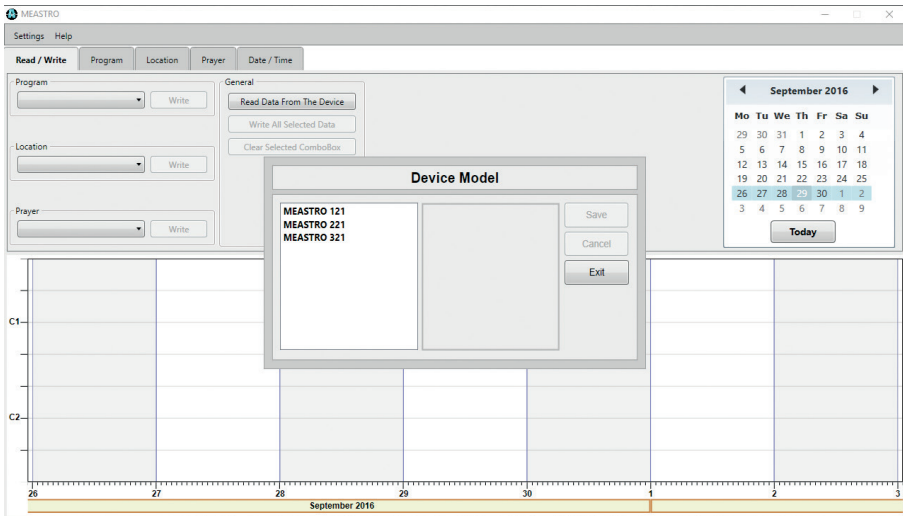

You can start using the software after selecting and saving your device model.

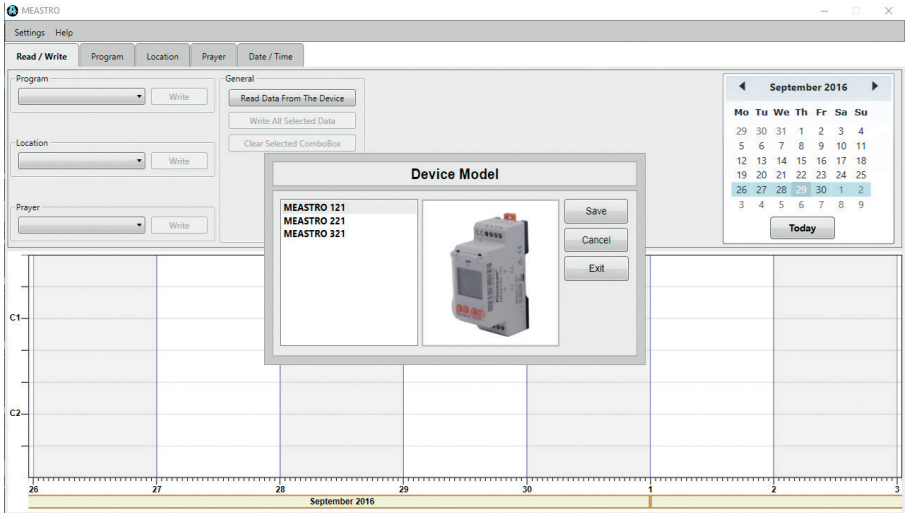





Kızılızüm Mahallesi Kemalpaşa Kızılızüm Cad. No:15 - 35730  
Kemalpaşa - İzmir / TURKEY Tel: (+90 232) 877 08 00 Fax: (+90 232) 877 08 06

[www.klemsan.com](http://www.klemsan.com) / [info@klemsan.com.tr](mailto:info@klemsan.com.tr)

**Klemsan**<sup>®</sup>  
Revizion No: 17072018