



Klemmsan®

270350 T1-60S

Single Functional

General

Order Number	270 350
Casing Width (mm)	17,5
Connections	Screw Terminal
Functions	ND
Type of Output	Relay
Adjustment of Timing-1 & Timing-2	--
Lux Adjustment Rate	--
Sensitivity Adjustment Rate	--
Supply Frequency	35-70 Hz
Trigger Input Voltage	--
Recovery Time	Maks. 100ms
Protection Class	IP20
Weight (g)	57
Mounting Type	Panel & Rail
Schematics	--
Dimensions	--

Auxiliary Contacts

Type	1 C/O (SPDT)
Max. Ratings - AC (for NO side)	5A/250V; 1250VA
Max. Ratings - DC (for NO side)	5A/30VDC; 150W
Mechanical Lifetime	≥ 10 ⁷ operations
Electrical Lifetime Operations (for NO side)	5x10 ⁴ (5A@250VAC) 1x 10 ⁵ (5A@30VDC)

Time Range

Timing-1	1s => 60s
----------	-----------

	Timing-2	--
Supply Voltage	DC	--
	AC	24-300VAC/DC
Ambient Conditions	Operating Temperature	-20 to + 60°C
	Storing Temperature	-40°C +75°C
	Relative Humidity (No Condensation)	Maks. 95%
Power Consumption	DC	<1.25W
	AC	<2.5VA
EMC-EMI	55011/A1, 61000-4-2, 61000-4-3/A1, 61000-4-4, 61000-4-5, 61000-4-6, 61000-4-8, 61000-4-11	✓
Liquid Level Electrode	Definition	--
	Order Number	--
	Packing Units	1

UL Sertifikası - UL Certificate

UL Sertifikası - UL Certificate

Avrupa standartlarına uygunluk belgesi - CE Certificate

Order Info

270350 Single Functional

Time & Control
Management Solutions



Timing is everything



Defining a timer in simple terms

A timer is an automation device that either keeps track of how much time has been spent doing something or that counts down a specified duration of time. After a predefined time has elapsed, the timer closes or opens its contact.

Which actions are executed?

Starting
Stopping
Delaying
Triggering

A timer can be used to **start** an action according to a predefined time or **stop** an action over a period of time. It can also add **delay** an action. It allows to control applications with its **trigger input** as well.

Benefits and Advantages

- High accuracy and switching reliability
- Sensitive timing range from 0.1sec to 10days
- High mechanical endurance
- Multifunctional operating modes
- Trigger input
- High level of Electromagnetic compatibility (EMC) i.e. maximum immunity to interferences.
- A widely range of power supply from (24 to 300VAC/DC)
- Sleek 17.5mm wide housing and compact design saves panel space.
- Perfect to fit in Modular Enclosure
- Protection against over voltage and reverse polarity
- Self-Extinguishing plastic housing

Mounting

Klemsan electronic timers are suitable for snap mounting onto 35 mm standards DIN rails.

Which markets are they used frequently?

- Industrial Machines
- Illuminating
- Construction industry
- HVAC systems
- Food and agriculture industry

Layout

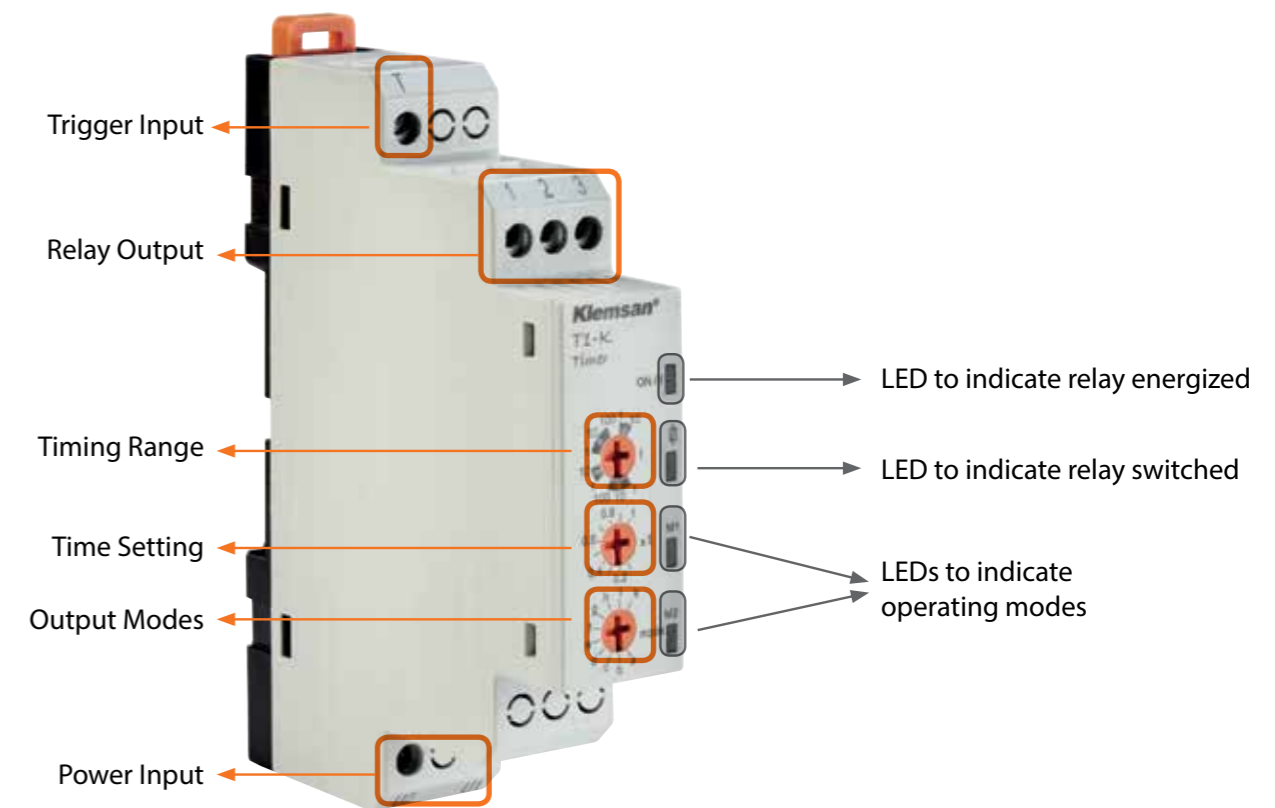

T1-K Multifunctional Timer



Conveyor Control

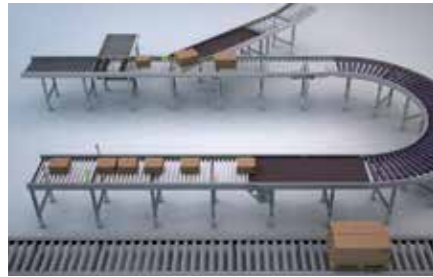

Managing the operation of a conveyor belt based on the time interval between products on the belt.



Timer
T1 series

Direction Control of Industrial Motor



Controls the direction of the motor's rotation.



TIMER
T1-LR

Star-Delta Starter

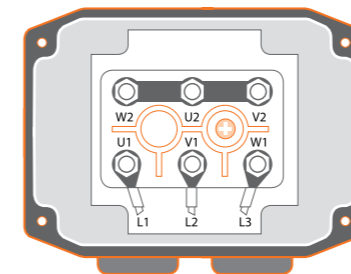

Successful run-up for industrial motors with star-delta relay.



Motor Starter Relay
SD1

Smart Lighting



Controlling flashing on lighted signs.



Timer
T1-Flash, T1-M4, T1-M5

Controlling Liquid Level in a Tank



It can be used to control the liquid level in a tank. Sensitivity resistance can be adjusted thus there is no need to change models to match different liquid types and concentrations.



Liquid Level Controller
LC3

Remote Machinery Control



Managing maintenance of the power supply in the event of a mains power failure, switching on an external backup power source for a given time.



Timer
T1 series

Billboard and Street Lighting



Controlling billboards and street lights with the accurate and precise time thanks to photocell relay.



Photocell Relay
PH1-20L

Vending Machines



Automatic management of vending machines.



Timer
T1-K

Packing Machine / System



Controlling heat sealing times on blister packs, packaging bags, etc.



Timer
T1-K, T1-M5, T1-M4



Type	T1-60S	T1-100S	T1-XS	T1-FLASH	T1-M4	Z1-M5	T1-M5	T1-K	T1-LR	SD1	PH1-20L	LC3
Timing Function	Single-functional	Single-functional	Single-functional	Single-functional	Multifunctional	Multifunctional	Multifunctional	Multifunctional	Single-functional	Single-functional	Single-functional	Single-functional
Definiton	On delay timer	On delay timer	On delay timer	Off flasher timer	Multimode timer	Multimode timer	Multimode timer	Multimode timer with trigger input	Left-right timer	Star-delta timer	Photocell relay with an external photocell sensor	Liquid level controller
Order Number	270350	270359	270357	270351	270355	270373	270353	270354	270356	270358	270050	270001
Casing Width(mm)	17.5	17.5	17.5	17.5	17.5	17.5	17.5	17.5	17.5	17.5	17.5	36
Connections	Screw terminal	Screw terminal	Screw terminal	Screw terminal	Screw terminal	Screw terminal	Screw terminal	Screw terminal	Screw terminal	Screw terminal	Screw terminal	Screw terminal
Functions	ND	ND	XS	Foff	ND,FD,Fon,Foff	ND,FD,NFD,Fon,Foff	ND,FD,NFD,Fon,Foff	a,b,c,d,e,f,g,h,i,k	LR	SD	PHL	LC
Type of Output	Relay	Relay	Relay	Relay	Relay	Relay	Relay	Relay	Two Relays	Two Relays	Relay	Relay
Auxiliary contacts	Type	1 C/O (SPDT)	1 C/O (SPDT)	1 C/O (SPDT)	1 C/O (SPDT)	1 C/O (SPDT)	1 C/O (SPDT)	1 C/O (SPDT)	2 x C/O	2 x C/O	1 C/O (SPDT)	1 C/O (SPDT)
	Max ratings-AC (for NO side)	5A/250V; 1250 VA	5A/250V; 1250 VA	5A/250V; 1250 VA	5A/250V; 1250 VA	5A/250V; 1250 VA	5A/250V; 1250 VA	5A/250V; 1250 VA	5A/250V; 1250 VA	5A/250V; 1250 VA	5A/250V; 1250 VA	5A/250V; 1250 VA
	Max ratings-DC (for NO side)	5A/30VDC; 150W	5A/30VDC; 150W	5A/30VDC; 150W	5A/30VDC; 150W	5A/30VDC; 150W	5A/30VDC; 150W	5A/30VDC; 150W	5A/30VDC; 150W	5A/30VDC; 150W	5A/30VDC; 150W	5A/30VDC; 150W
	Mechanical life time	≥ 10 ⁷ operations	≥ 10 ⁷ operations	≥ 10 ⁷ operations	≥ 10 ⁷ operations	≥ 10 ⁷ operations	≥ 10 ⁷ operations	≥ 10 ⁷ operations	≥ 10 ⁷ operations	≥ 10 ⁷ operations	≥ 10 ⁷ operations	≥ 10 ⁷ operations
	Electrical life time operations (for NO side)	5×10 ⁴ (5A@250VAC) 1×10 ⁵ (5A@30VDC)	5×10 ⁴ (5A@250VAC) 1×10 ⁵ (5A@30VDC)	5×10 ⁴ (5A@250VAC) 1×10 ⁵ (5A@30VDC)	5×10 ⁴ (5A@250VAC) 1×10 ⁵ (5A@30VDC)	5×10 ⁴ (5A@250VAC) 1×10 ⁵ (5A@30VDC)	5×10 ⁴ (5A@250VAC) 1×10 ⁵ (5A@30VDC)	5×10 ⁴ (5A@250VAC) 1×10 ⁵ (5A@30VDC)	5×10 ⁴ (5A@250VAC) 1×10 ⁵ (5A@30VDC)	5×10 ⁴ (5A@250VAC) 1×10 ⁵ (5A@30VDC)	5×10 ⁴ (5A@250VAC) 1×10 ⁵ (5A@30VDC)	5×10 ⁴ (5A@250VAC) 1×10 ⁵ (5A@30VDC)
Adjustment of Timing-1 & Timing-2	-	-	-	independent	independent	dependent	dependent	-	independent	independent	independent	-
Time Range	Timing-1	1s =>60s	1s =>100s	1s =>2559s	0.1s =>10d	1s =>10d	0.1s =>10d	0.1s =>10d	0.1s =>10d	0.1s =>10d	1s =>30s	1s =>45s
	Timing-2	-	-	-	0.1s =>10d	1s =>10d	0.1s =>10d	0.1s =>10d	-	0.1s =>10d	20ms=>500ms	1s =>45s
Lux adjustment range	-	-	-	-	-	-	-	-	-	-	1-20Lux	-
Sensitivity adjustment range	-	-	-	-	-	-	-	-	-	-	-	5-100kΩ
Supply Voltage	DC	24-300 VDC	24VDC	24-300 VDC	24-300 VDC	24-300 VDC	12VDC	24-300 VDC	24-300 VDC	24-300 VDC	-	24-300 VDC
	AC	24-300 VAC	24VAC or 180-265 VAC	24-300 VAC	24-300 VAC	24-300 VAC	12VAC or 180-265 VAC	24-300 VAC	24-300 VAC	24-300 VAC	150-500 VAC	24-300 VAC
Supply Frequency	35-70 Hz	35-70 Hz	35-70 Hz	35-70 Hz	35-70 Hz	35-70 Hz	35-70 Hz	35-70 Hz	35-70 Hz	35-70 Hz	35-70 Hz	35-70 Hz
Trigger Input Voltage	-	-	-	-	-	-	-	24-300 VAC/DC	-	-	-	-
Permissible ambient temperature	During operation	-20 to +60 °C	-20 to +60 °C	-20 to +60 °C	-20 to +60 °C	-20 to +60 °C	-20 to +60 °C	-20 to +60 °C	-20 to +60 °C	-20 to +60 °C	-20 to +60 °C	-20 to +60 °C
	During storage	-40 to +75 °C	-40 to +75 °C	-40 to +75 °C	-40 to +75 °C	-40 to +75 °C	-40 to +75 °C	-40 to +75 °C	-40 to +75 °C	-40 to +75 °C	-40 to +75 °C	-40 to +75 °C
Relative Humidity	Max. 95% (no condensation)	Max. 95% (no condensation)	Max. 95% (no condensation)	Max. 95% (no condensation)	Max. 95% (no condensation)	Max. 95% (no condensation)	Max. 95% (no condensation)	Max. 95% (no condensation)	Max. 95% (no condensation)	Max. 95% (no condensation)	Max. 95% (no condensation)	Max. 95% (no condensation)
Recovery time	Max. 100ms	Max. 100ms	Max. 100ms	Max. 100ms	Max. 100ms	Max. 100ms	Max. 100ms	Max. 100ms	Max. 100ms	Max. 100ms	Max. 100ms	Max. 100ms
Degree of protection	IP20	IP20	IP20	IP20	IP20	IP20	IP20	IP20	IP20	IP20	IP20	IP20
Power consumption	DC	<1.25W	<1W	<1.25W	<1.25W	<1.25W	<1.25W	<1.25W	<1.25W	<1.25W	<1.25W	-
	AC	<2.5VA	<13VA	<2.5VA	<2.5VA	<2.5VA	<2.5VA	<2.5VA	<2.5VA	<2.5VA	<2.5VA	<7VA
Weight(gr)	57	57	62	60	60	60	60	66	70	70	63	82



Type		T1-60S	T1-100S	T1-XS	T1-FLASH	T1-M4	Z1-M5	T1-M5	T1-K	T1-LR	SD1	PH1-20L	LC3
Permissible mounting position		any	any	any	any	any	any	any	any	any	any	any	any
EMC-EMI	55011/A1, 61000-4-2, 61000-4-3/A1, 61000-4-4, 61000-4-5, 61000-4-6, 61000-4-8, 61000-4-11	OK	OK	OK	OK	OK	-	OK	OK	OK	OK	OK	OK
Accessories	Liquid Level Electrode	-	-	-	-	-	-	-	-	-	-	-	Liquid Level probe for LC3
	Definiton	-	-	-	-	-	-	-	-	-	-	-	280610
	Order Number	-	-	-	-	-	-	-	-	-	-	-	1 pc.
	Packaging unit	-	-	-	-	-	-	-	-	-	-	-	1 pc.

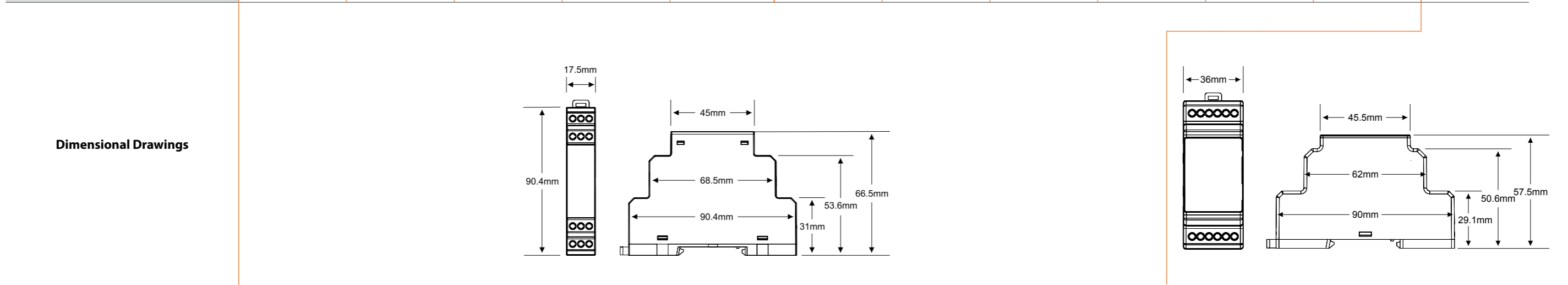
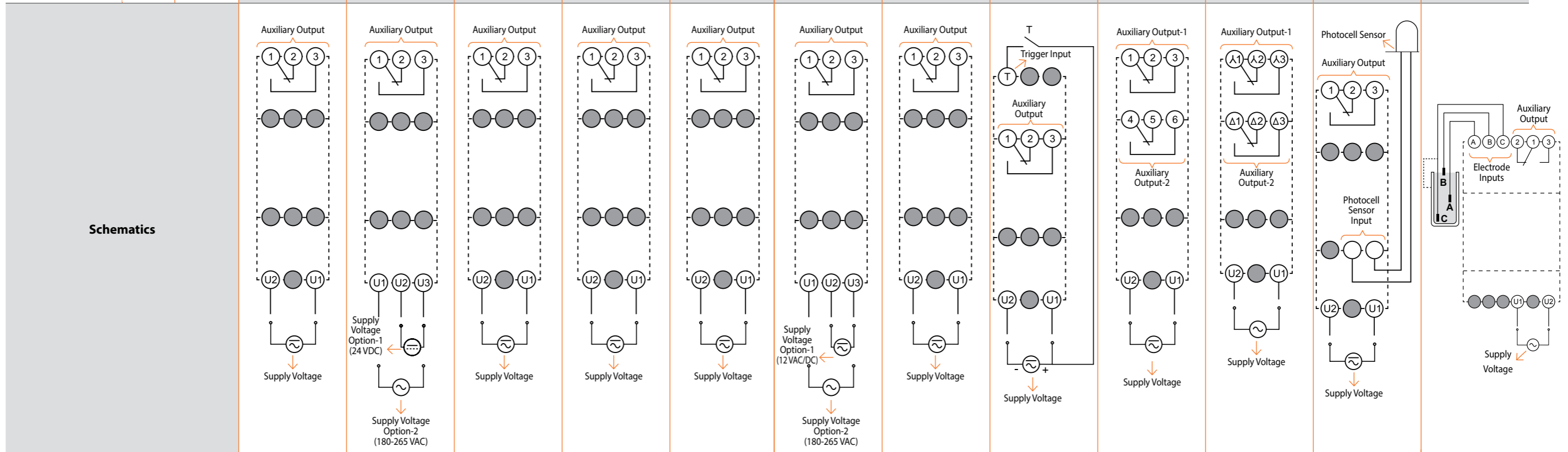



a & ND functions / On delay operation

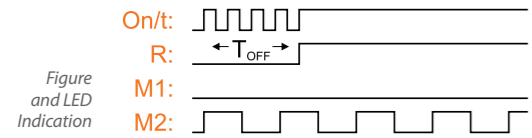

The output relay is initially de-energized and energized after an adjustable time delay, t_{off} .

b & FD functions / Off delay operation

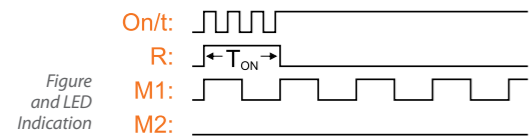

The output relay is initially energized and de-energized after an adjustable time delay, t_{on} .

NFD function / On-Off delay operation

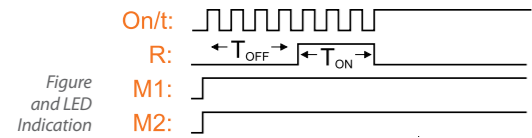

The output relay is initially de-energized and energized after an adjustable time delay, t_{off} and stays energized for an adjustable period, t_{on} and then de-energized.

Fon function / On flasher operation

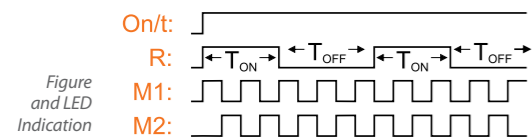

The output relay is initially energized and de-energized after an adjustable time delay, t_{on} and stays de-energized for an adjustable period, t_{off} and then energized. This loop is repeated until the device is powered off. "On/t" led flashes at Fon and Foff mode for "T1-M4" product.

g and Foff functions / Off flasher operation

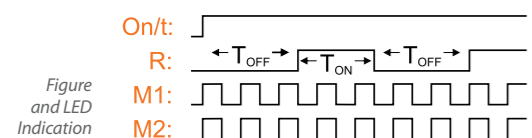

The output relay is initially de-energized and energized after an adjustable time delay, t_{off} and stays energized for an adjustable period, t_{on} and then de-energized. This loop is repeated until the device is powered off. "On/t" led flashes at Fon and Foff mode for "T1-M4" product.

c function / On delay with control input

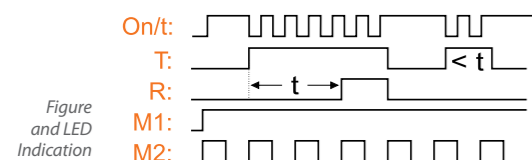

The output relay is initially de-energized. A contact closure on T contact triggers an adjustable time delay, t , which energizes the output relay when expired. The output relay stays energized as long as the T contact is active. Delay time, t , is cleared when the contact on T contact opens.

d function / Off delay with control input

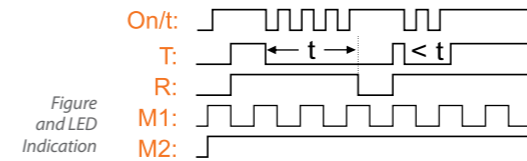

The output relay is initially de-energized and energized when a contact closure on T contact is detected. A contact triggers an adjustable time delay, t , which de-energizes the output relay when expired. Reclosure of the contact on T contact before the time delay is expired restarts time delay, t , and keeps the output relay energized.

e function / Rising edge triggered off delay

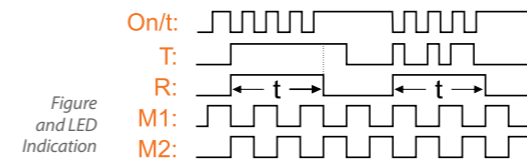

The output relay is initially de-energized. A contact closure on T contact both energizes the output relay and triggers an adjustable time delay, t , which de-energizes the output relay when expired. During the time delay, T contact is insensitive to state changes and becomes sensitive when time delay, t , expired.

f function / Falling edge triggered off delay

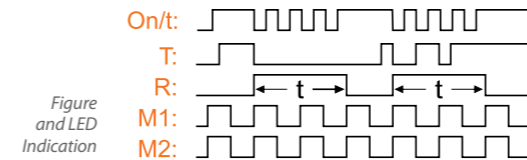

The output relay is initially de-energized. A state change of the T contact from closed to open both energizes the output relay and triggers an adjustable time delay, t , which de-energizes the output relay when expired. During the time delay, T contact is insensitive to state changes and becomes sensitive when time delay, t , expired.

h function / On and off delay with control input

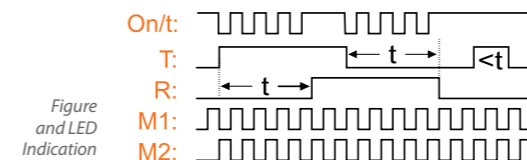

The output relay is initially de-energized. A contact closure on T contact triggers an adjustable time delay, t , which energizes the output relay when expired. Similarly contact release of T contact triggers the time delay, t , which de-energizes the output relay when expired. Delay time, t , is cleared when the contact state of T contact changes.

i function / Adjustable pulse output with control input

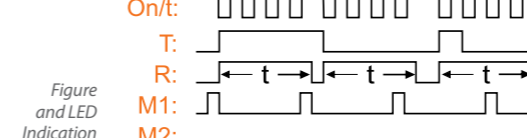

The output relay is initially de-energized. A state change on T contact both energizes the output relay and triggers an adjustable time delay, t , which de-energizes the output relay when expired. During the time delay, T contact is insensitive to state changes and becomes sensitive when time delay, t , expired.

k function / On delay with memory

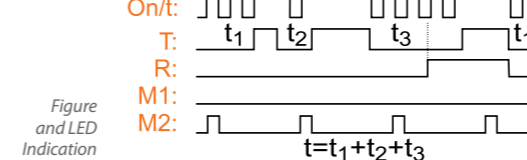

The output relay is initially de-energized. If T contact is open, adjustable time delay, t , counts down and output relay energizes when t is expired. Any contact closure on T contact pauses the count down process and the process continues when the contact release on T contact occurs. A contact release is needed to restart the cycle, after the output relay is energized.



XS function / On delay adjustment for each second

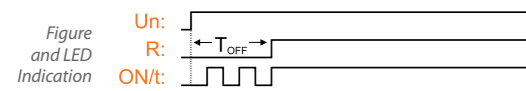

T1-XS is an ON delay timer that allows a sensitive time setting from 1 to 2559 seconds with 1 second increments. The output relay is initially de-energized and energized after the time delay t is expired.

SD function / Star-Delta operation

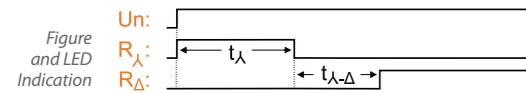

When the energy applied to device, star relay is energized until the end of the adjustable t_λ time. At the end of the adjusted delay time $t_{\lambda-\Delta}$, delta relay is energized until the device is powered off.

LR function / Left-Right operation

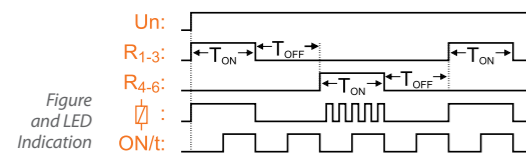

Initially first relay is energized. After the adjustable time delay t_{on} , relay is de-energized. Both relays are de-energized during the adjustable time delay t_{off} . At the end of t_{off} , second relay energizes. Second relay stays in this position during t_{on} . When t_{on} finished both relays are de-energized. This cycle is repeated continuously.

PHL function / Photocell operation

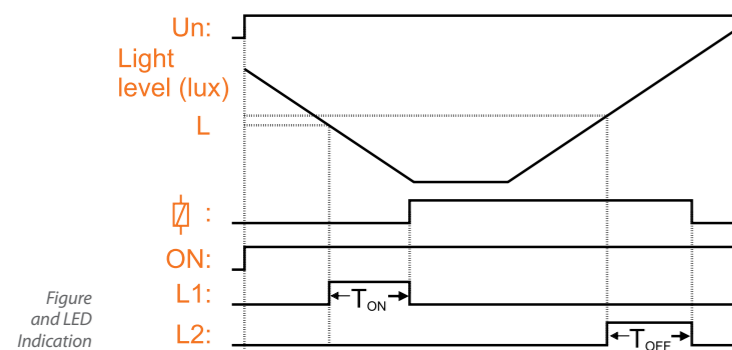

PH1-20L photocell relay measures the luminous intensity by means of a photocell sensor. On-off threshold value is adjusted in the range of 1-20 lux, via the front adjustment dial. The output relay is energized when the ambient light level is below the adjusted limit. On and off delays are adjustable between 1 and 45 seconds, via the front panel knobs. On delay is adjusted by t_{on} knob, and off delay is adjusted by t_{off} knob.

LC function / Liquid Level Operation

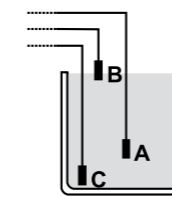
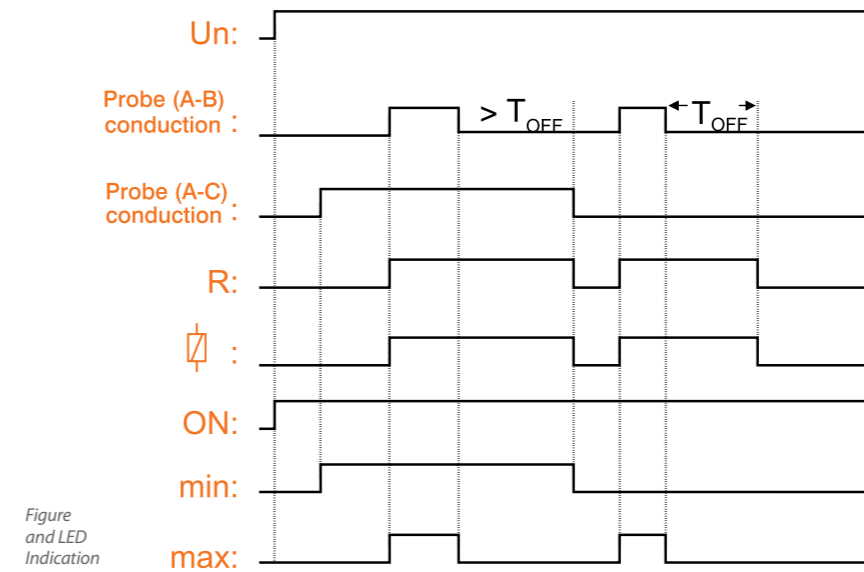

3 electrodes mode:

When the level of liquid in the tank reaches to electrode B, the output relay is activated and stays in this position even if the level drops below the electrode B level. The output relay is deactivated when the liquid level drops below the electrode A level. Re-activation occurs when the level reaches to the electrode B level.

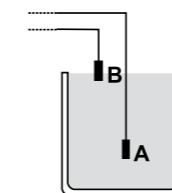

2 electrodes mode:

For 2 electrodes mode of operation, A and B electrodes are used. When level of liquid in the tank reaches to electrode B, output relay is activated. When the liquid level drops below electrode B and continually stays there for the adjustable time delay (adjusted on the front panel knob); output relay will be de-energized.

Klemsan® Timers

Operating voltage 24 .. 300V AC/DC
24V AC/DC or 180..265V AC (T1-100S, T1-30S)

Adjustment values



Time range :
(T1-M5, T1-FLASH, T1-K)
1s : 1 second 1h : 1 hour
10s : 10 seconds 10h : 10 hours
100s : 100 seconds 100h : 100 hours
1m : 1 minute 1d : 1 day
10m : 10 minutes 10d : 10 days

Time range :
(T1-M4)

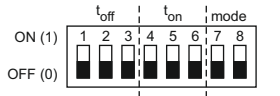

t_{on} (4,5,6), t_{off} (1,2,3) mode (7,8)
000 : 10 seconds 00 : on delay
001 : 30 seconds 01 : off delay
010 : 100 seconds 10 : on flasher
011 : 10 minutes 11 : off flasher
100 : 60 minutes
101 : 100 hours
110 : 100 hours
111 : 10 days

t_{on} , t_{off} multiplier value :
(T1-M5, T1-FLASH) 0.1 - 0.2 - 0.3 - 0.4 - 0.5 - 0.6 - 0.7 - 0.8
0.9 - 1



t multiplier value :
(T1-K) 0.1 - 0.2 - 0.3 - 0.4 - 0.5 - 0.6 - 0.7 - 0.8
0.9 - 1

t, t_{on} , t_{off} timer :
(time range) x (multiplier value)
time range :
1 .. 60 seconds (T1-60S, T1-60S2)
1 .. 100 seconds (T1-100S)
1 .. 30 seconds (T1-30S)

Output contact	1 C/O
Maximum switching current	10A
Maximum switching voltage	250V AC
Maximum switching power	1250VA
Operating temperature	-20°C .. 60°C
Storage temperature	-40°C .. 75°C
Protection class	IP20
Connection	Rail mounted

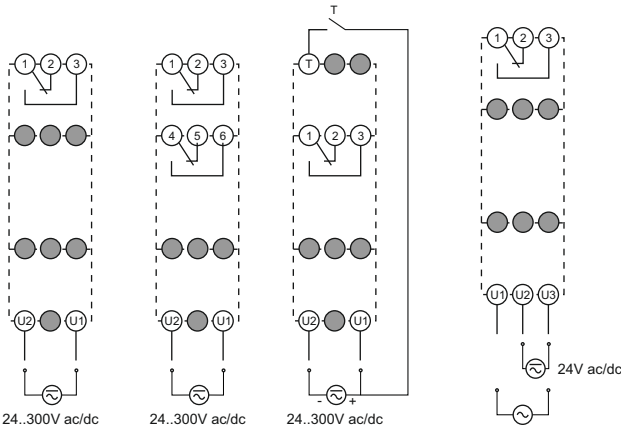
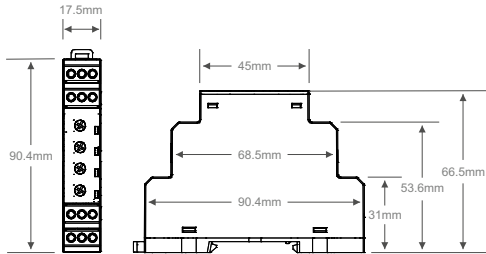

T1-M5, T1-FLASH, T1-M4, T1-60S

T1-60S2

T1-K

T1-100S, T1-30S

type	control input	mode	time range	order no
T1-60S		ND	1 .. 60sec	270 350
T1-FLASH		Foff	0.1sec .. 10days	270 351
T1-60S2		ND	1 .. 60sec	270 352
T1-M5		ND,FD,NFD,Fon,Foff	0.1sec .. 10days	270 353
T1-K	✓	a,b,c,d,e,f,g,h,i,k	0.1sec .. 10days	270 354
T1-M4		ND,FD,Fon,Foff	1sec .. 10days	270 355
T1-100S		ND	1 .. 100sec	270 359
T1-30S		ND	1 .. 30sec	270 363

OPERATION MODE	FUNCTION ILLUSTRATION	FUNCTION STATEMENT
on delay (mode: a, ND)	On/t: R: M1: M2:	The output relay is initially de-energized and energized after an adjustable time delay, t_{on} .
off delay (mode: b, FD)	On/t: R: M1: M2:	The output relay is initially energized and de-energized after an adjustable time delay, t_{off} .
on-off delay (mode: NFD)	On/t: R: M1: M2:	The output relays is initially de-energized and energized after an adjustable time delay, t_{on} , and stays energized for an adjustable period, t_{on} , and then de-energized.
on flasher (mode: Fon)	On/t: R: M1: M2:	The output relays is initially energized and de-energized after an adjustable time delay, t_{on} , and stays de-energized for an adjustable period, t_{off} , and then energized. This loop is repeated until the device is powered off. "On/t" led flashes at Fon and Foff mode for "T1-M4" product.
off flasher (mode: g, Foff)	On/t: R: M1: M2:	The output relay is initially de-energized and energized after an adjustable time delay, t_{on} , and stays energized for an adjustable period, t_{on} , and then de-energized. This loop is repeated until the device is powered off. "On/t" led flashes at Fon and Foff mode for "T1-M4" product.
on delay with control input (mode: c)	On/t: T: R: M1: M2:	The output relay is initially de-energized. A contact closure on T contact triggers an adjustable time delay, t, which energizes the output relay when expired. The output relay stays energized as long as the T contact is active. Delay time, t, is cleared when the contact on T contact opens.
off delay with control input (mode: d)	On/t: T: R: M1: M2:	The output relay is initially de-energized and energized when a contact closure on T contact is detected. A contact release on T contact triggers an adjustable time delay, t, which de-energizes the output relay when expired. Reclosure of the contact on T contact before the time delay is expired restarts time delay, t, and keeps the output relay energized.
rising edge triggered off delay (mode: e)	On/t: T: R: M1: M2:	The output relay is initially de-energized. A contact closure on T contact both energizes the output relay and triggers an adjustable time delay, t, which de-energizes the output relay when expired. During the time delay, T contact is insensitive to state changes and becomes sensitive when time delay, t, expired.
falling edge triggered off delay (mode: f)	On/t: T: R: M1: M2:	The output relay is initially de-energized. A state change of the contact on T contact from closed to open both energizes the output relay and triggers an adjustable time delay, t, which de-energizes the output relay when expired. During the time delay, T contact is insensitive to state changes and becomes sensitive when time delay, t, expired.
on and off delay with control input (mode: h)	On/t: T: R: M1: M2:	The output relay is initially de-energized. A contact closure on T contact triggers an adjustable time delay, t, which energizes the output relay when expired. Similarly contact release of T contact triggers the time delay, t, which de-energizes the output relay when expired. Delay time, t, is cleared when the contact state of T contact changes.
adjustable pulse output with control input (mode: i)	On/t: T: R: M1: M2:	The output relay is initially de-energized. A state change on T contact both energizes the output relay and triggers an adjustable time delay, t, which de-energizes the output relay when expired. During the time delay, T contact is insensitive to state changes and becomes sensitive when time delay, t, expired.
on delay with memory (mode: k)	On/t: T: R: M1: M2:	The output relay is initially de-energized. If T contact is open, adjustable time delay, t, counts down and output relay energizes when t is expired. Any contact closure on T contact pauses the count down process, and the process continues when the contact release on T contact occurs. A contact release is needed to restart the cycle, after the output relay is energized.

Warning : If adjustments are accomplished after Timer is turned on, operator should power down the device, wait at least 0.3 seconds and power up the device.